

# ミジンコ

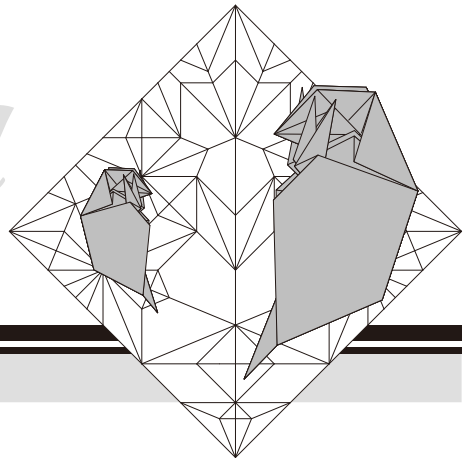

作/図 河本 泰岳 東北大学占部研究室  
Urabe lab @Tohoku Univ.  
創作:2016/4/15 作図:2016/5/18 chlamydoselachusanguineus@gmail.com

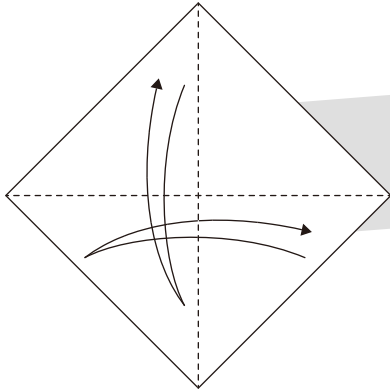

1.対角線に折り筋をつける  
Fold and unfold along the diagonals.

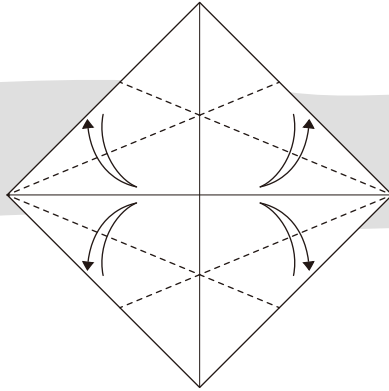

2.フチを中心に合わせて折り筋をつける  
Fold the edges in to lie along the diagonals and unfold.

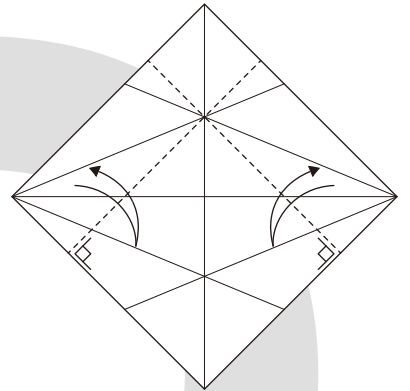

3.交点を通る線で折り筋をつける  
Fold the lines through the intersection and unfold.

6.フチを合わせて折る  
Fold the edge up to the top edge.

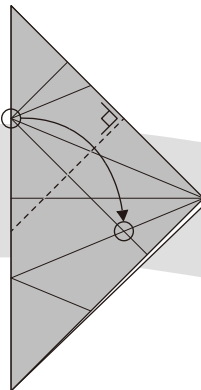
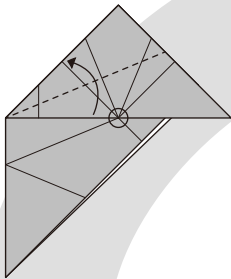

5.○印の点を合わせて折る (次図参照)  
Fold the circled point to the other.  
Watch at the circled point on the next diagram, too.

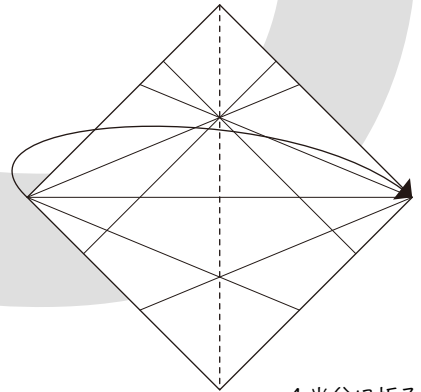

4.半分に折る  
Fold in half.

7.開く  
Unfold.

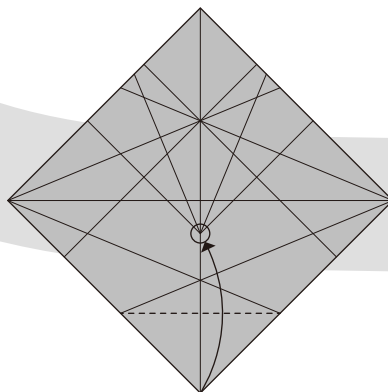
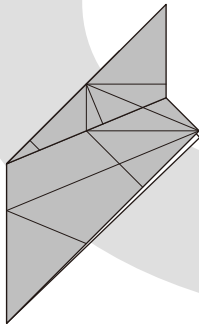

8.○印に合わせてカドを折りあげる  
Fold the bottom corner to the circled point.

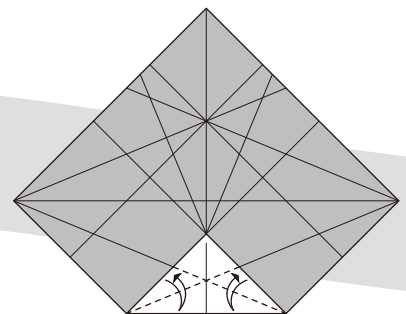

9.フチに合わせて折り筋をつける  
Fold the edges down to the bottom edge and unfold.

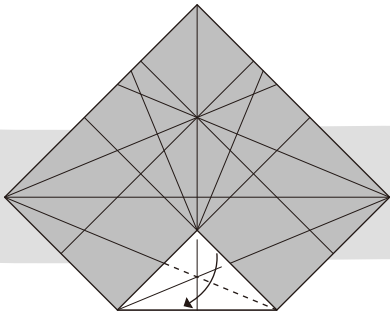

10.つけた折り目で折る  
Fold on the existing crease.

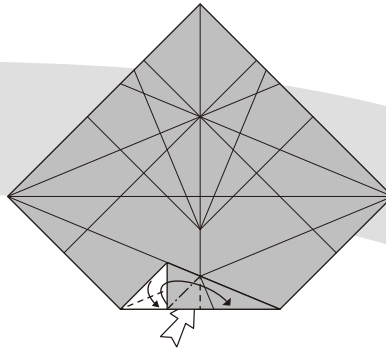

11.引き寄せ折り  
Swivel fold.

12.裏返す  
Turn the paper over.

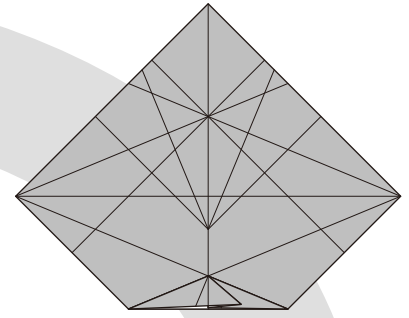

17.紙を引き出して開く  
手順18~21は立体的になる  
Pull out the layers. Step 18-21 will be 3-D.

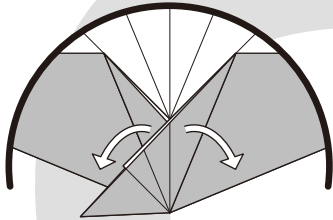

16.カドを反対側に折る  
Fold the flap to the other side.

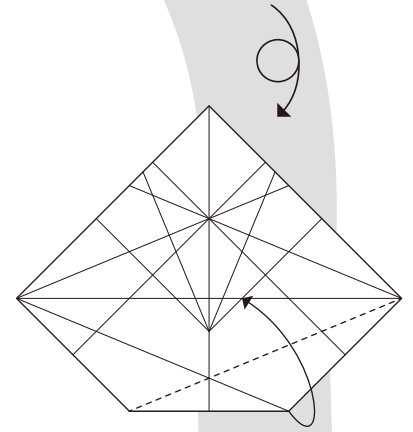
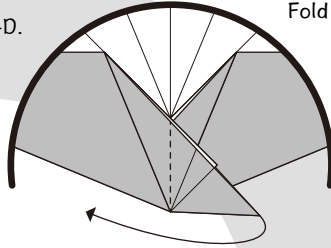

13.ついている折り目で折る  
Valley-fold on the exiting crease.

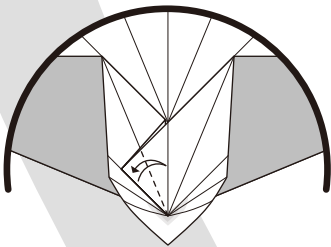

18.フチを中心に合わせて折り筋をつける  
Fold the edge in to lie along  
the center crease and unfold.

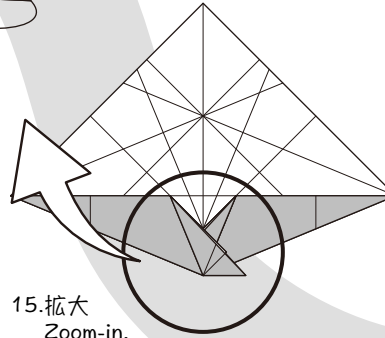

15.拡大  
Zoom-in.

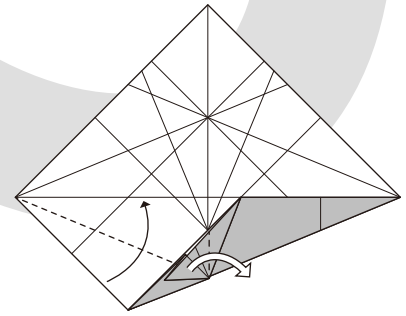

14.引き寄せ折るように折る  
Fold like swivel fold.

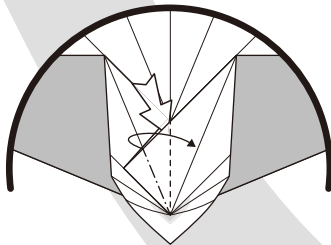

19.つけた折り目で内側を  
開いて潰すように折る  
Squash fold.

20.カドを後ろに折り込む  
Mountain-fold the flaps  
on the existing creases.

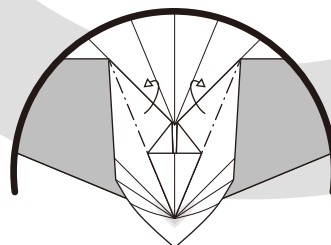

21.手順17のように閉じる  
Close the flap like step 17.

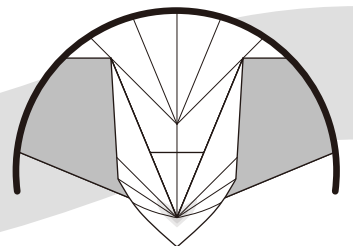

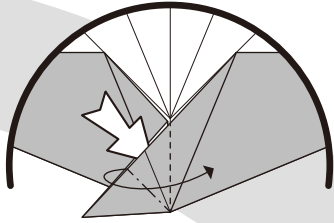

22.内側を広げて潰すように折る  
Squash fold.

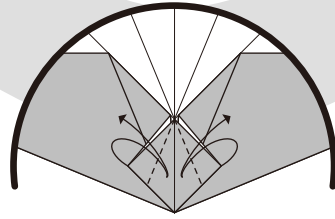

23.フチを中心に合わせて折り筋をつける  
Fold the edges in to lie along  
the center crease and unfold.

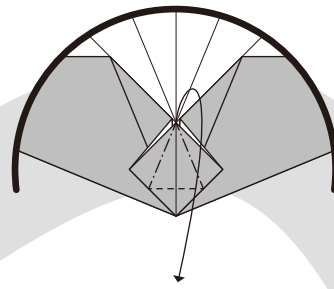

24.花弁折り  
Petal fold.

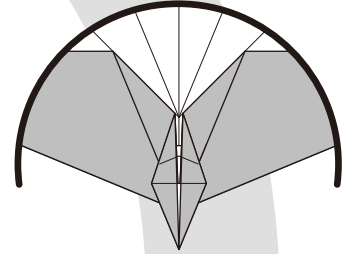

25.視点を手順15に戻す  
Zoom-out.

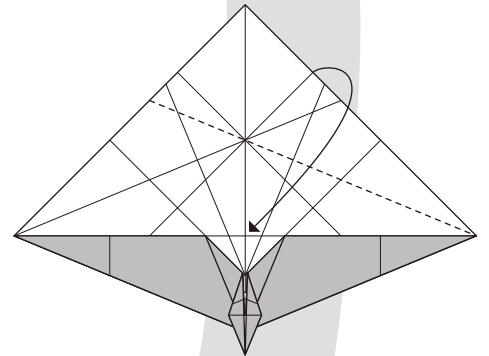

26.ついている折り目で谷折り  
Valley-fold on the existing crease.

29.つけた折り目で内側を開いて潰すように折る  
Squash fold.

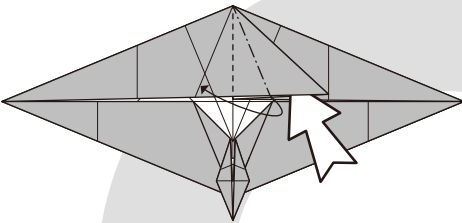

28.フチを中心に合わせて折り筋をつける  
Fold the edge in to lie along  
the center crease and unfold.

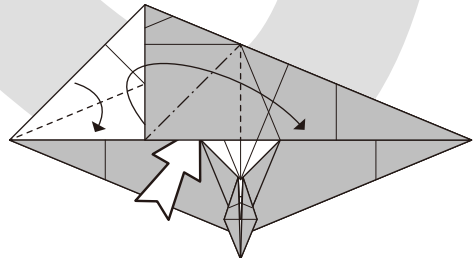
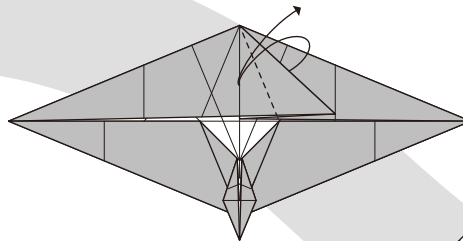

27.引き寄せ折り  
Swivel fold.

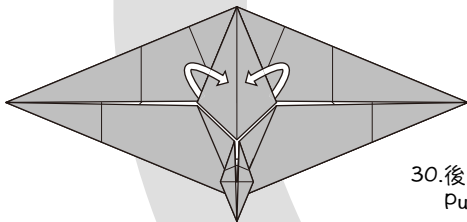

30.後ろのヒダを引き出す  
Pull out the hind layers.

33.フチとフチを合わせて折り筋をつける  
Fold the angle bisector and unfold.

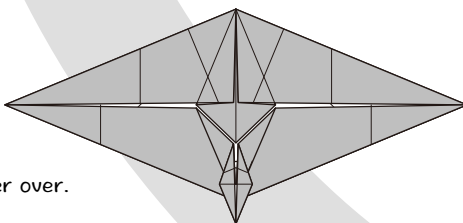

31.裏返す  
Turn the paper over.

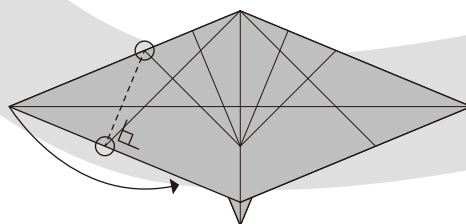

32.○印を結ぶ線で谷折り  
Fold along the line connecting circled points.

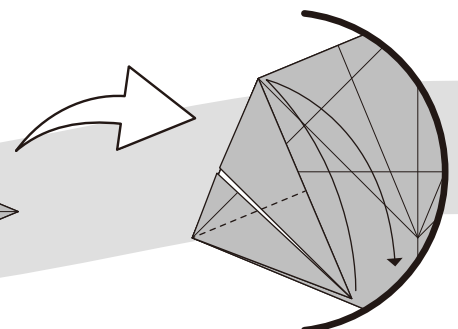

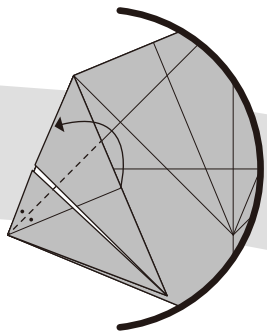

34.つけた折り目をフチに合わせて谷折り  
Fold the crease in to lie along the edge.

35.ついている折り目で谷折り  
Valley-fold on the existing crease.

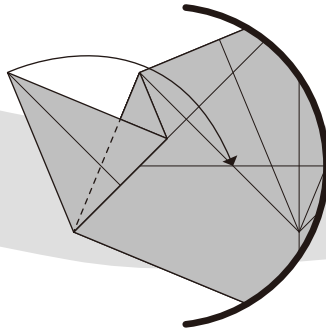

36.フチとフチを合わせて谷折り  
Valley-fold the angle bisector.

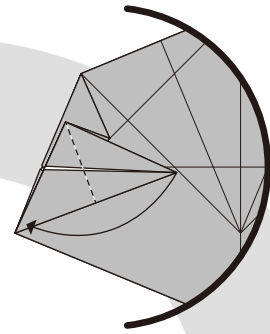

39.反対側も同じ  
Repeat steps 32-37 on the other side.

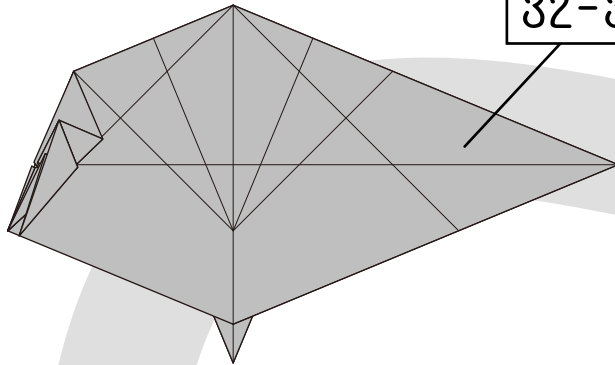

32-37

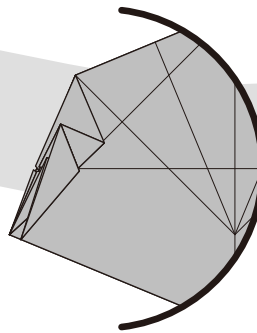

38.視点を戻す  
Zoom-out.

37.中割り折り  
Inside reverse fold.

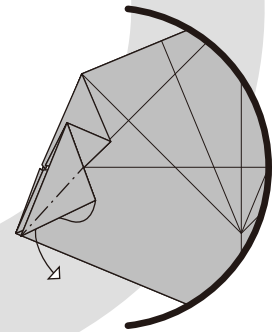

40.ついている折り目で山折り  
Mountain-fold on the existing crease.

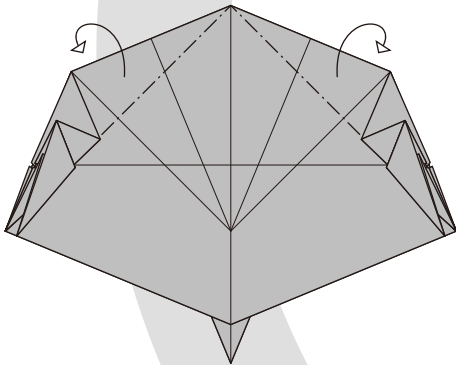

43.ついている折り目で両側で内側へ段折り  
Crimp inside on the existing creases.

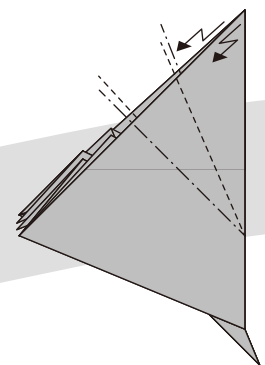

41.半分に山折り  
Mountain-fold in half.

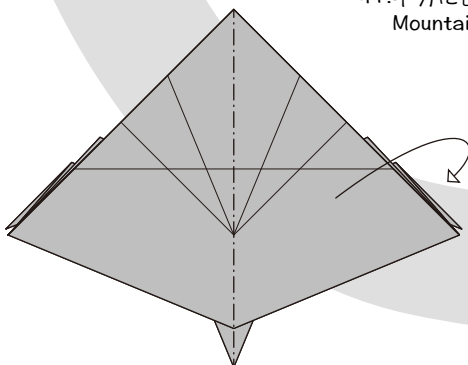

42.○印を中心に円を描くようにカドを引き出す  
内側のヒダがはみ出ないように注意  
Swivel the flap around the circled point.  
Note that the inside edge should not  
jut out the outside edge.

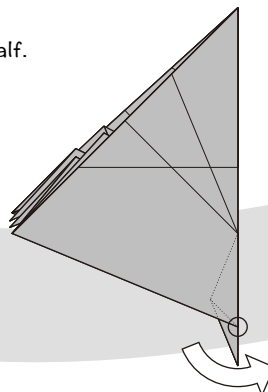

45. ついている折り目に沿う折り線で  
ねじるように山折り  
■部は折らずに起き上がるようにする(次図参照)  
Mountain-fold as you wrench the flap over.  
Note that you should not fold a shaded area.  
Watch at the same area in the next diagram, too.

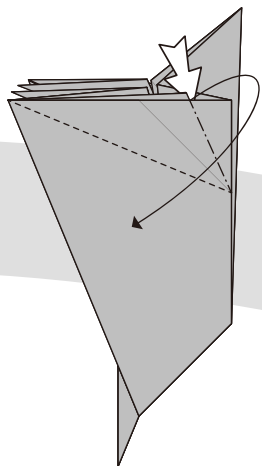

44. 引き寄せ折り  
Swivel fold.

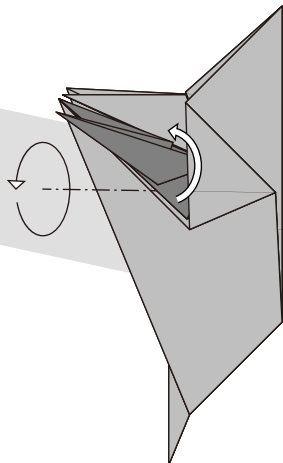

46. 中割り折り  
Inside reverse fold.

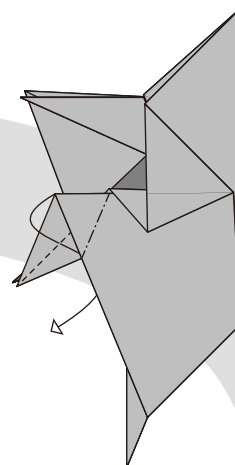

52. カドを引き出す  
Pull out the flaps.

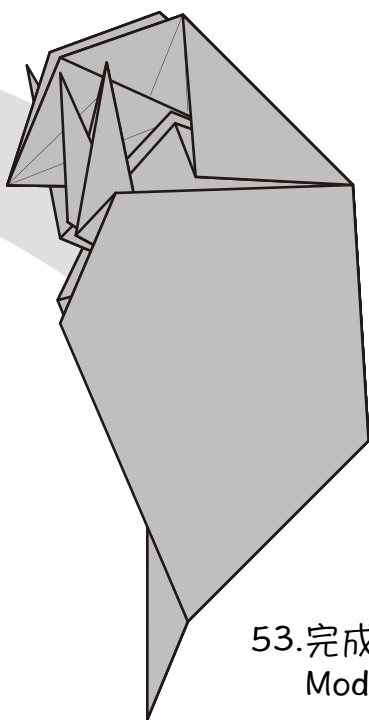
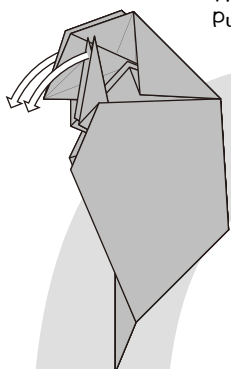

53. 完成  
Model completed.

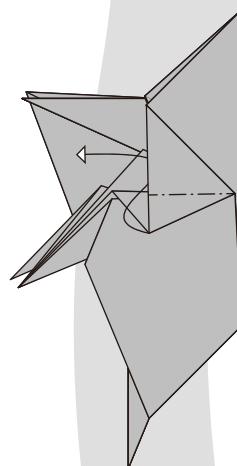

47. 中割り折り  
Inside reverse fold.

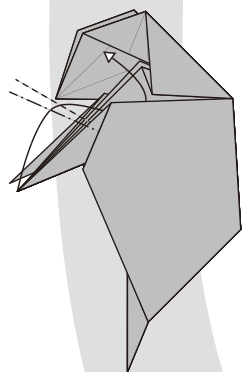

51. 2つのカドを合わせて中割り折り  
反対側も同じ  
Inside reverse fold including both flaps.  
Repeat behind.

44-47

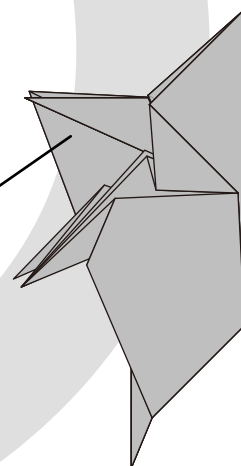

48. 反対側も同じ  
Repeat steps 44-47 behind.

50. 重なっている紙を引き出す  
Pull out the layers.

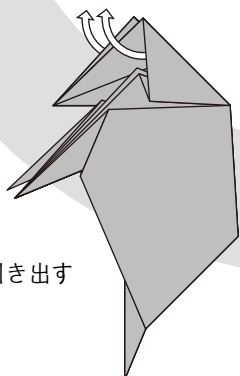

49. 中割り折り  
Inside reverse fold.

